

*PERFECT  
LIGHT*

**CANTONI**<sup>®</sup>  
CANTONI TRADING SRL  
ITALY

*WIDE  
SPACE*

*EVERYTIME  
ON TOP*





|            |    |   |    |  |
|------------|----|---|----|--|
|            | 6  | <b>VT - VP LINE</b>   | 59 | MDW.s                                    |
|            | 8  | VT101.C   | 60 | MW01.STK <b>NEW</b>                      |
|            | 10 | VT101.C.TR  | 62 | MDT                                      |
|            | 12 | VT103   | 64 | MDT                                      |
|            | 14 | VT.BE   | 65 | MW01.T                                   |
|            | 16 | VPE.S-10  | 66 | LTV - LTVX2                              |
|            | 18 | VPET-10   | 68 | <b>BAG &amp; TROLLEY - SUITCASE LINE</b> |
|            | 20 | VPP.SP  | 70 | HIGHBOX TROLL.FR - FITBOX TROLL.FR       |
| <b>NEW</b> | 22 | VT.NAILS  | 71 | BEAUTYBOX TROLL.FR - BMT.3               |
| <b>NEW</b> | 23 | ST.N - ST.N BAG   | 72 | BMT.6                                    |
| <b>NEW</b> | 24 | KIT LNS   | 73 | BMU.3 - BMU.6                            |
|            | 26 | <b>VOYAGER LINE</b>   | 74 | BB2.T - BB2.N                            |
|            | 28 | VOYSL.TR-10   | 75 | GV.NAILS - GV10                          |
|            | 30 | VOYSL.SLIM.TR-10  | 76 | <b>ACCESSORIES</b>                       |
|            | 32 | <b>WORKSTATION LINE</b>                                       | 76 | ST113 - ST114 - KH - B03                 |
|            | 34 | L400.N-10 FO  | 77 | STOOL - X4+SX4                           |
|            | 36 | L200.N-10 FO  | 78 | TRI 650 - W806 + WOS3003                 |
|            | 38 | L400X2 - L200X2 - LCN   | 79 | TRI 425 - W06 + WU43                     |
|            | 40 | <b>LINEA SEDIE PROFESSIONALI<br/>PROFESSIONAL CHAIRS LINE</b> |    | GREAT TRANSPORT                          |
|            | 42 | S102.N  |    |  |
|            | 44 | S104  |    |  |
| <b>NEW</b> | 46 | S105.A  |    |  |
|            | 48 | S102.A  |    |  |
| <b>NEW</b> | 50 | S102.A 2H   |    |  |
|            | 52 | <b>MIRROLINE</b>  |    |  |
|            | 54 | MAKE UP CORNER STAND ALONE                                    |    |  |
|            | 56 | WALL MOUNT  |    |  |
| <b>NEW</b> | 57 | MCR NEW   |    |  |
|            | 58 | MDW   |    |  |

*INDICE*

*INDEX*

WHENEVER YOU NEED IT      WHEREVER YOU ARE



IN SMALL SPACE



MADE IN ITALY

www.cantonionline.com



Showroom

Cantoni nasce nel 1996 da un'idea di un fotografo ed una truccatrice, che lavorando spesso in location, come capita a molti make up artists, si trovavano di frequente a dover lavorare in condizioni poco appropriate.

Dopo aver ideato e realizzato il primo modello di postazione trucco trasportabile per proprio uso personale, decisero di commercializzare "la valigia con le gambe" e la risposta del mercato fu subito un successo.

Oggi Cantoni è orgogliosa di continuare ad annoverare fra i propri clienti i Marchi più prestigiosi del settore. La gamma Cantoni è venduta nel mondo intero tramite distributori esclusivi che hanno deciso di puntare sul marchio Cantoni per dare ulteriore prestigio al loro prodotto.

Ogni anno si aggiungono prodotti innovativi e tecnologicamente avanzati, con creazioni sempre più differenziate e con soluzioni esclusive e assolutamente originali.

I prodotti Cantoni esprimono con fermezza la filosofia aziendale.

Design, qualità e funzionalità sono i pilastri imprescindibili alla base di ogni creazione.

Da anni l'obiettivo primario è quello di fornire una gamma di prodotti di alta qualità dedicati ai professionisti della moda, del make up, dell'estetica e della fotografia.

La nostra forza sta nel conoscere a fondo le problematiche del settore potendo quindi fornire soluzioni mirate.

Ogni minimo dettaglio delle creazioni Cantoni è accuratamente studiato per fornire la massima praticità a tutti gli operatori del settore, senza rinunciare a un design esclusivo d'inconfondibile impronta Italiana.



Ufficio Tecnico - Technical office

Cantoni Company was established in 1996 from an idea of a photographer and a make up artist. Both of them, working frequently on location, needed to find a solution to be well equipped in any circumstance.

They made the first prototype of portable make up station for personal use, then they decided to launch it on the market. And...the market reaction was very positive.

To this day Cantoni is very proud to continue enumerating the most famous Cosmetic Brands among his customers.

The Cantoni range is distributed all over the world by exclusive vendors.

Every year the range of products is improved and widened with new exclusive and technical solutions. Our watchwords are: design, quality and functionality.

Our goal is to provide high quality products dedicated to beauty sector professionals, such as make up artists, hairstylists, beauticians and photographers.

Our key factor is to know deeply the problems to provide the right solutions.

Every detail is carefully supervised in order to make all our creations the more convenient for the users, without forgoing Italian design .



Magazzino,Ufficio,Unità di Assemblaggio  
Warehouse,Office,Assembling unit



Ufficio Commerciale - Sales office



Amministrazione - Administration



Mascotte: Molli

## LINEA VT-VP

### POSTAZIONI TRUCCO TRASPORTABILI

Valigie di produzione artigianale italiana, con scocche in ABS, stile "flight case", gambe telescopiche e trolley incorporati, profili in alluminio anodizzato.

Realizzate in diversi modelli e misure per offrire soluzioni mirate alle diverse esigenze ed avere tutto in ordine e sempre a disposizione.

- ▶ RESISTENZA & LEGGEREZZA
- ▶ TRASPORTABILITÀ
- ▶ DI FACILE PULIZIA
- ▶ ILLUMINAZIONE PROFESSIONALE PER MAKE UP\*\*

TECNOLOGIA **I-LIGHT** PER UNA LUCE PERFETTA GLI SPECIALI CUPOLINI DIFFONDONO UNA LUCE RADIOSA ED AVVOLGENTE, con una resa costante nel tempo

- VERSIONE DIMMER: regolazione intensità progressiva
- VERSIONE ON/OFF: nessuna regolazione
- BASSO CONSUMO
- LUNGA DURATA
- ALTO LIVELLO DI SICUREZZA

- ▶ GARANZIA 2 ANNI & CERTIFICAZIONE CE

Caratteristica fondamentale delle POSTAZIONI CANTONI è l'estrema facilità e velocità in apertura e in chiusura, le gambette telescopiche sono incorporate e non si devono agganciare separatamente.

Durante il trasporto, o quando è necessario riporle, queste postazioni si trasformano in una valigia estremamente COMPATTA e MANEGGEVOLE, poiché formata da un corpo unico.



## VT-VP LINE

### PORTABLE MAKE UP STATIONS

Italian handmade production, these items are composed by ABS moulded shells "flight case style".

Provided with integrated Telescopic Stands and Incorporated trolley. Aluminum extrusion finishings.

Available in various models and dimensions to offer solutions that perfectly satisfy the customer specific needs in terms of aesthetics and functionality, to always have all well organized.

- ▶ DURABILITY & LIGHTNESS
- ▶ PORTABILITY
- ▶ EASY TO CLEAN
- ▶ PROFESSIONAL LIGHTING EXPRESSEDLY DESIGNED FOR MAKE UP\*\*

THE **I-LIGHT** TECHNOLOGY SYSTEM CREATES A PERFECT ILLUMINATION, THE CAPS DIFFUSE THE LIGHT, and maintain a constant over time performance

- DIMMER VERSION: Adjustable intensity of the light
- ON/OFF VERSION: no regulation
- LOW POWER CONSUMPTION
- LONG LIFE
- HIGH LEVEL OF SAFETY STANDARDS

- ▶ 2 YEAR WARRANTY & CE CERTIFICATION

During the transport, or when it is necessary to put it back, this station transforms quickly into a very COMPACT and MANAGEABLE suitcase, since it is formed by a unique body. Essential characteristic of the CANTONI STATIONS is the extreme simplicity and smartness when opening and closing the station, as the telescopic stands are incorporated so they don't need to be screwed to the structure.

\*\*Brevetto Europeo

\*\*EU Patented





# ART. VT101.C



Internamente dotata di scomparti con alette, a chiusura magnetica, in alluminio verniciato resistenti al calore, che, in apertura, fungono da piani d'appoggio. Ampio specchio illuminato e presa di corrente.

## POSTAZIONE FISSA

- Profumerie, saloni, backstage ● ● ● ●
- Istituti di bellezza, parrucchieri ● ● ● ●
- Accademie ● ● ●
- Vetrine ● ● ● ●

## POSTAZIONE MOBILE

- Trucco a domicilio ● ● ● ● ● ●
- Set cinematografici in esterno ● ● ● ● ● ●



Internally equipped with a container provided of several compartments, the bigger one has 2 panels in black heatproof aluminium which functions as support base and also as cover with magnetic locks. Wide illuminated mirror with I-LIGHT technology system, 6 spot light, socket. Recommended for:

## IN PLACE

- Perfumeries, salons, fashion backstage ● ● ● ●
- Beauty institutes, SPA, hairdressers ● ● ● ●
- Make up academies ● ● ●
- Point of sale, visual merchandising ● ● ● ●

## ON THE MOVE

- Wedding & home services ● ● ● ● ● ●
- Movie backstages ● ● ● ● ● ●





ACCESSORI - ACCESSORIES



**COVER**  
Borsa portavaligia in tessuto tecnico, imbottita, per protezione contro gli urti durante il trasporto.



**COVER**  
Shockproof protection bag in softpadded fabric material.

**LEGGIO**

Molto utile per avere i progetti sempre visibili. Possibilità di abbinarlo anche alle valigie in fase di ordine delle stesse.



**BOOKREST**

Very useful to place projects. It is possible to require this accessory combined with our portable make up stations exclusively when ordering them.



SCHEDA TECNICA - TECHNICAL DETAIL

| Modello<br>Model | A<br>mm | B<br>mm | C<br>mm | D<br>mm | E<br>mm |         |
|------------------|---------|---------|---------|---------|---------|---------|
| VT101.C          | 630     | 490     | 240     | 70      | 170     | 13,5 kg |

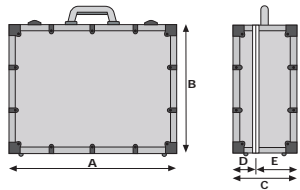

Altezza piano di lavoro:  
940 mm con estensione  
massima delle gambe  
telescopiche.  
Table top height:  
940 mm  
(max extension)

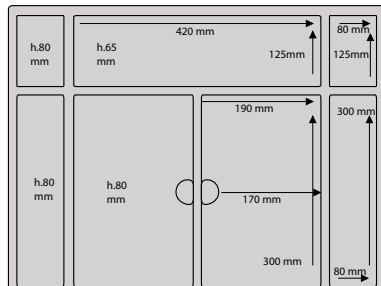

# ART. VT101.C.TR



Internamente dotata di vassoi scorrevoli a chiusura magnetica che, in apertura, fungono da piano d'appoggio. Contenitore interno molto profondo per una maggiore capienza. Ampio specchio illuminato e presa di corrente.

## POSTAZIONE FISSA

- Profumerie, saloni, backstage ●●●●
- Istituti di bellezza, parrucchieri ●●●●
- Accademie ●●●
- Vetrine ●●●●

## POSTAZIONE MOBILE

- Trucco a domicilio ●●●●
- Set cinematografici in esterno ●●●●



Internally equipped with a container provided of several compartments, the bigger one has 2 sliding trays, with magnetic locks, which functions as support base during make up performance, the bigger container is very deep for a greater capacity. Wide illuminated mirror with I-LIGHT technology system, 6 spot light, socket.

Recommended for:

## IN PLACE

- Perfumeries, salons, fashion backstage ●●●●
- Beauty institutes, SPA, hairdressers ●●●●
- Make up academies ●●●
- Point of sale, visual merchandising ●●●●

## ON THE MOVE

- Wedding & home services ●●●●
- Movie backstages ●●●●



ACCESSORI - ACCESSORIES



**COVER**

Borsa portavaligia in tessuto tecnico, imbottita, per protezione contro gli urti durante il trasporto.



**COVER**

Shockproof protection bag in softpadded fabric material.

**LEGGIO**

Molto utile per avere i progetti sempre visibili. Possibilità di abbinarlo anche alle valigie in fase di ordine delle stesse.



**BOOKREST**

Very useful to place projects. It is possible to require this accessory combined with our portable make up stations exclusively when ordering them.



SCHEDA TECNICA - TECHNICAL DETAIL

| Modell o Model | A mm | B mm | C mm | D mm | E mm |  |
|----------------|------|------|------|------|------|---|
| VT101.C.TR     | 630  | 490  | 240  | 70   | 170  | 13,5 kg   |

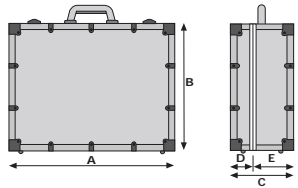

Altezza piano di lavoro:  
940 mm con estensione  
massima delle gambe  
telescopiche.  
Table top height:  
940 mm  
(max extension)

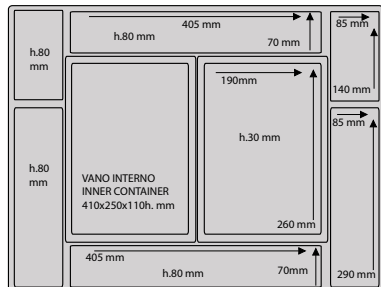



Questo modello estremamente versatile, è dotato di un cassetto laterale scorrevole, a chiusura magnetica, che esce dal corpo valigia, in questo modo si ottengono ulteriori spazi di alloggiamento e di appoggio. Il contenitore interno, di grande capienza, è dotato di un vassoio scorrevole a chiusura magnetica che, in apertura, diventa un ulteriore spazio di lavoro. Ampio specchio illuminato e presa di corrente.

POSTAZIONE FISSA

- Profumerie, saloni, backstage ●●●●●
- Istituti di bellezza, parrucchieri ●●●●●
- Accademie ●●●
- Vetrine ●●●●●

POSTAZIONE MOBILE

- Trucco a domicilio ●●●
- Set cinematografici in esterno ●●●●●



This model, extremely versatile, is provided of 1 lateral sliding drawer, secured with magnetic lock, which is enclosed in the body of the case. This way all spaces are fully utilized, furthermore when the drawer is open it can be useful as support base. The inner compartment, very spacious, is provided with a front sliding tray which functions as cover, with magnetic lock, and as further support base. Wide illuminated mirror with I-LIGHT technology system, 6 spot light, socket. Recommended for:

IN PLACE

- Perfumeries, salons, fashion backstage ●●●●●
- Beauty institutes, SPA, hairdressers ●●●●●
- Make up academies ●●●
- Point of sale, visual merchandising ●●●●●

ON THE MOVE

- Wedding & home services ●●●
- Movie backstages ●●●●●



ACCESSORI - ACCESSORIES



**COVER**

Borsa portavaligia in tessuto tecnico, imbottita, per protezione contro gli urti durante il trasporto.



**COVER**

Shockproof protection bag in softpadded fabric material.

**LEGGIO**

Molto utile per avere i progetti sempre visibili. Possibilità di abbinarlo anche alle valigie in fase di ordine delle stesse.



**BOOKREST**

Very useful to place projects. It is possible to require this accessory combined with our portable make up stations exclusively when ordering them.



SCHEDA TECNICA - TECHNICAL DETAIL

| Modello<br>Model | A<br>mm | B<br>mm | C<br>mm | D<br>mm | E<br>mm |       |
|------------------|---------|---------|---------|---------|---------|-------|
| VT103            | 635     | 485     | 300     | 70      | 230     | 15 kg |

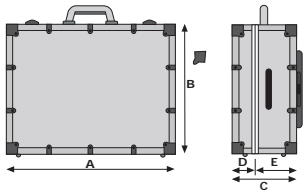

cass.laterale - lateral drawer

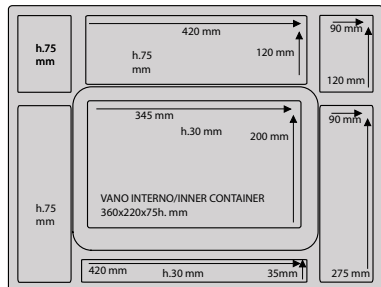
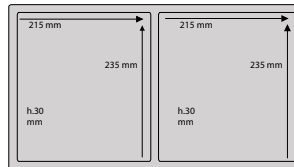

Altezza piano di lavoro:  
940 mm con estensione  
massima delle gambe  
telescopiche.  
Table top height: 940 mm  
(max extension)





Versione ULTRASLIM della linea, studiata per rendere ancora più agevole il trasporto, è stata creata con un peso ed uno spessore ridotto, mantenendo comunque uno spazio di lavoro comodo ed efficiente. Il contenitore interno è dotato di divisori regolabili, 2 vassoi estraibili che fungono da chiusura del fondo, e durante l'utilizzo vengono posizionati sui lati tramite agganci speciali. Ampio specchio illuminato e presa di corrente.

POSTAZIONE FISSA

- Profumerie, saloni, backstage ●●●
- Istituti di bellezza, parrucchieri ●●●
- Accademie ●●●
- Vetrine ●●●

POSTAZIONE MOBILE

- Trucco a domicilio ●●●●●
- Set cinematografici in esterno ●●●●●



This is the ULTRASLIM version of the line, very easy to transport for its very low weight and dimensions, keeping the comfort and efficiency. The inner compartment is provided with adjustable dividers, 2 pull out trays which function as covers, to keep safe the contents, and during the make up performance can be hooked up to the sides of the case to obtain more support bases. Wide illuminated mirror with I-LIGHT technology system, 6 spot light, socket. Recommended for:

IN PLACE

- Perfumeries, salons, fashion backstage ●●●
- Beauty institutes, SPA, hairdressers ●●●
- Make up academies ●●●
- Point of sale, visual merchandising ●●●

ON THE MOVE

- Wedding & home services ●●●●●
- Movie backstages ●●●●●



ACCESSORI - ACCESSORIES



**COVER**

Borsa portavaligia in tessuto tecnico, imbottita, per protezione contro gli urti durante il trasporto.



**LEGGIO**

Molto utile per avere i progetti sempre visibili. Possibilità di abbinarlo anche alle valigie in fase di ordine delle stesse.



**COVER**

Shockproof protection bag in softpadded fabric material.

**BOOKREST**

Very useful to place projects. It is possible to require this accessory combined with our portable make up stations exclusively when ordering them.



SCHEDA TECNICA - TECHNICAL DETAIL

| Modello<br>Model | A<br>mm | B<br>mm | C<br>mm | D<br>mm | E<br>mm |       |
|------------------|---------|---------|---------|---------|---------|-------|
| VT.BE            | 635     | 485     | 240     | 70      | 170     | 13 kg |

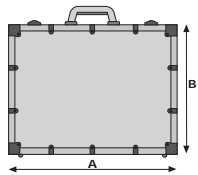

Altezza piano di lavoro:  
890 mm con estensione  
massima delle gambe  
telescopiche.  
Table top height:  
890 mm  
(max extension)

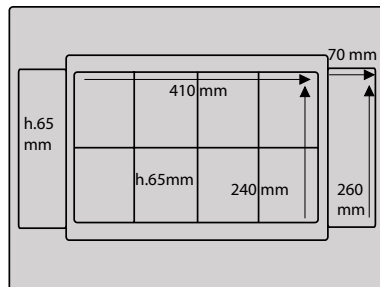

Vassoi - Trays

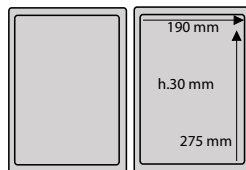

# ART. VPE.S-10



Questo modello è consigliato per un utilizzo "itinerante", grazie al peso e alle dimensioni, o come postazione "fissa" dove lo spazio è ridotto. È dotata di un cassetto laterale scorrevole che esce dal corpo valigia, con chiusura magnetica, di un contenitore con divisori regolabili e 2 vassoi estraibili a chiusura del fondo che, posizionati ai lati tramite speciali agganci aumentano lo spazio di lavoro. Ampio specchio illuminato e presa di corrente.

## POSTAZIONE FISSA

- Profumerie, saloni, backstage ●●●
- Istituti di bellezza, parrucchieri ●●●
- Accademie ●●●
- Vetrine ●●●

## POSTAZIONE MOBILE

- Trucco a domicilio ●●●●●
- Set cinematografici in esterno ●●●●●



This model is very suitable for people whose work involves frequent moves, thanks to its weight and dimensions, but it is very appropriate in place too, where the space is small. It is provided of 1 lateral sliding drawer, secured with magnetic lock, which is enclosed in the body of the case. The inner compartment with adjustable dividers, 2 pull out trays which function as covers, to keep safe the contents, and during the make up performance can be hooked up to the sides of the case to obtain more support bases. Wide illuminated mirror with I-LIGHT technology system, 6 spot light, socket.

Recommended for:

## IN PLACE

- Perfumeries, salons, fashion backstage ●●●
- Beauty institutes, SPA, hairdressers ●●●
- Make up academies ●●●
- Point of sale, visual merchandising ●●●

## ON THE MOVE

- Wedding & home services ●●●●●
- Movie backstages ●●●●●





ACCESSORI - ACCESSORIES



**COVER**

Borsa portavaligia in tessuto tecnico, imbottita, per protezione contro gli urti durante il trasporto.



**COVER**

Shockproof protection bag in softpadded fabric material.

**LEGGIO**

Molto utile per avere i progetti sempre visibili. Possibilità di abbinarlo anche alle valigie in fase di ordine delle stesse.



**BOOKREST**

Very useful to place projects. It is possible to require this accessory combined with our portable make up stations exclusively when ordering them.



SCHEDA TECNICA - TECHNICAL DETAIL

| Modello<br>Model | A<br>mm | B<br>mm | C<br>mm | D<br>mm | E<br>mm |       |
|------------------|---------|---------|---------|---------|---------|-------|
| VPE.S-10         | 540     | 460     | 300     | 70      | 230     | 12 kg |

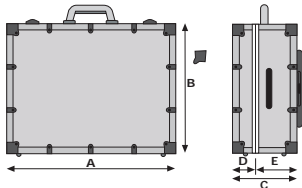

cass.laterale - lateral drawer

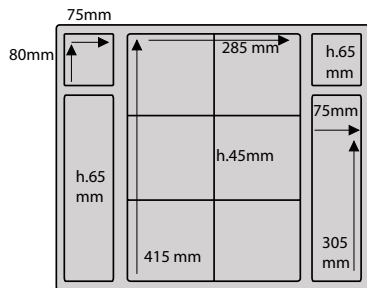
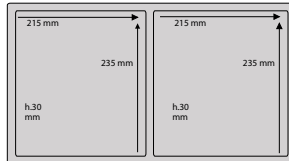

Vassoi - Trays

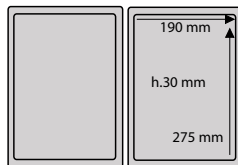

## ART. VPET-10



La più piccola e leggera della linea, prevalentemente consigliata per un utilizzo itinerante.

Il contenitore interno è dotato di divisori regolabili, spazi per alloggiamento pennelli o matite, 2 vassoi estraibili che fungono da chiusura del fondo, e durante l'utilizzo vengono posizionati sui lati tramite agganci speciali.

Ampio specchio illuminato e presa di corrente.

### POSTAZIONE FISSA

Profumerie, saloni, backstage ●●

Istituti di bellezza, parrucchieri ●●

Accademie ●●

Vetrine ●●

### POSTAZIONE MOBILE

Trucco a domicilio ●●●●●●

Set cinematografici in esterno ●●●●●●



The smallest and the lightest of the line, mainly recommended for free and fast moving. The inner compartment is provided of adjustable dividers, 2 pull out trays which function as covers, to keep safe the contents, and during the make up performance can be hooked up to the sides of the case to obtain more support bases. Wide illuminated mirror with I-LIGHT technology system, 6 spot light, socket.

Recommended for:

### IN PLACE

Perfumeries, salons, fashion backstage ●●

Beauty institutes, SPA, hairdressers ●●

Make up academies ●●

Point of sale, visual merchandising ●●

### ON THE MOVE

Wedding & home services ●●●●●●

Movie backstages ●●●●●●



ACCESSORI - ACCESSORIES



**COVER**

Borsa portavaligia in tessuto tecnico, imbottita, per protezione contro gli urti durante il trasporto.



**COVER**

Shockproof protection bag in softpadded fabric material.

**LEGGIO**

Molto utile per avere i progetti sempre visibili. Possibilità di abbinarlo anche alle valigie in fase di ordine delle stesse.



**BOOKREST**

Very useful to place projects. It is possible to require this accessory combined with our portable make up stations exclusively when ordering them.



SCHEDA TECNICA - TECHNICAL DETAIL

| Modello<br>Model | A<br>mm | B<br>mm | C<br>mm | D<br>mm | E<br>mm |        |
|------------------|---------|---------|---------|---------|---------|--------|
| VPET-10          | 540     | 460     | 225     | 70      | 155     | 11,5kg |

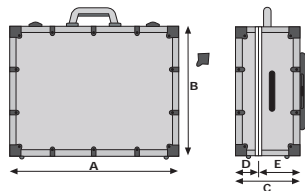

Altezza piano di lavoro:  
900 mm con estensione  
massima delle gambe  
telescopiche.  
Table top height: 900 mm  
(max extension)

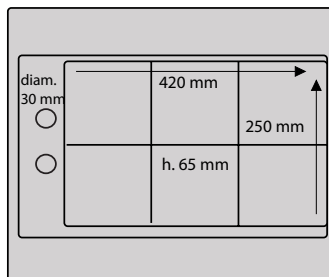

Vassoi - Trays

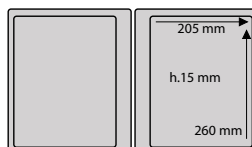



Questo modello è stato studiato per rendere più semplice e comodo l'utilizzo da parte dei parrucchieri, con spazi di alloggiamento per gli strumenti da loro utilizzati: è fornito di contenitore interno con divisori regolabili e 2 vassoi di chiusura. I vassoi sono posizionabili sui lati della postazione come piani di appoggio. Supporto per phon e piastre. Specchio dotato di 2 prese di corrente.

POSTAZIONE MOBILE

- Trucco e parruccho a domicilio ●●●●●
- Set cinematografici ●●●●●
- Moda ●●●●●
- Backstage ●●●●●



This model is dedicated to the hairstylists, to make their work easier in location, with appropriate spaces for hair tools, it is provided of 2 pull out trays which function as covers, to keep safe the contents, and during the performance can be hooked up to the sides of the case to obtain more support bases. Stand for hairdryer and hair straightener. Wide mirror with 2 sockets. Recommended for:

POSTAZIONE MOBILE

- Wedding & home services ●●●●●
- Movie backstages ●●●●●
- Fashion ●●●●●
- Fashion backstages ●●●●●



ACCESSORI - ACCESSORIES



COVER

Borsa portavaligia in tessuto tecnico, imbottita, per protezione contro gli urti durante il trasporto.



COVER

Shockproof protection bag in softpadded fabric material.

LEGGIO

Molto utile per avere i progetti sempre visibili. Possibilità di abbinarlo anche alle valigie in fase di ordine delle stesse.



BOOKREST

Very useful to place projects. It is possible to require this accessory combined with our portable make up stations exclusively when ordering them.



SCHEDA TECNICA - TECHNICAL DETAIL

| Modello<br>Model | A<br>mm | B<br>mm | C<br>mm | D<br>mm | E<br>mm |         |
|------------------|---------|---------|---------|---------|---------|---------|
| V.P.P.SP         | 540     | 460     | 225     | 70      | 155     | 10,5 kg |

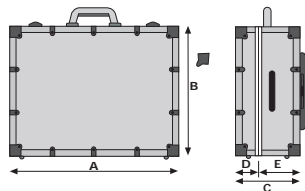

Altezza piano di lavoro:  
900 mm con estensione  
massima delle gambe  
telescopiche.  
Table top height: 900 mm  
(max extension)

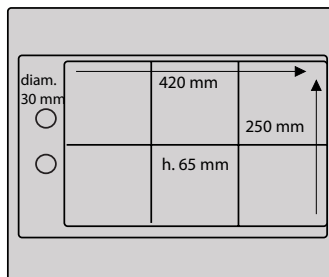

Vassoi - Trays

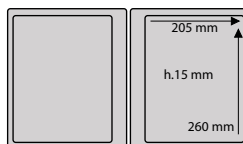



## BANCO UNGHIE TRASPORTABILE

- aggancio universale per lampada
- piano di lavoro resistente ai solventi
- cassetti laterali scorrevoli
- gambette telescopiche regolabili

Trolley incorporato per un facile trasporto



## PORTABLE NAIL STATION

- universal hook device for slim lamp
- antiscratch worktop solvent resistant
- lateral sliding drawers
- adjustable telescopic stands

Incorporated trolley for an easy transport



### SCHEDA TECNICA TECHNICAL DETAIL

| Modello<br>Model | A<br>mm | B<br>mm | C<br>mm |  |
|------------------|---------|---------|---------|--|
| VT.NAILS         | 640     | 490     | 180     | 11,5kg   |

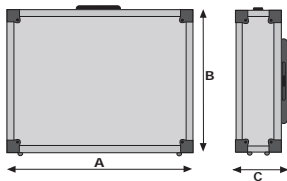

## ART. VT.NAILS

NEW





Predisposizione per aggancio universale per lampada



Universal hook device fitting space for slim lamp



Altezza piano di lavoro: 750 mm  
Max. estensione gambe telescopiche : 880 mm

Suggested work table height: 750 mm  
Table top max extension: 880 mm



### SGABELLI

Sgabelli pieghevoli in legno laccato, con seduta in materiale lavabile

2 Versioni disponibili

STN.BAG - con tasche portatutto per il professionista

STN - per il cliente



### STOOLS

Foldable stools, in painted wood, sitting in washable fabric

2 Variations available

STN.BAG - with pockets, useful for the professional

STN - for the client



STN.BAG

NEW



STN

NEW



## ART. KIT LNS



### TAVOLO UNGHIE CON SGABELLI

In legno laccato, design giovane e moderno.  
Arreda con allegria.

- piano di lavoro resistente ai solventi
- cassetto
- sgabelli con seduta imbottita



### NAIL DESK WITH STOOLS

in painted wood, modern design.  
Decorates with a fresh-look.

- table top solvent resistant
- drawer
- stools with padded sitting



ART. KIT LNS



SCHEDA TECNICA - TECHNICAL DETAIL

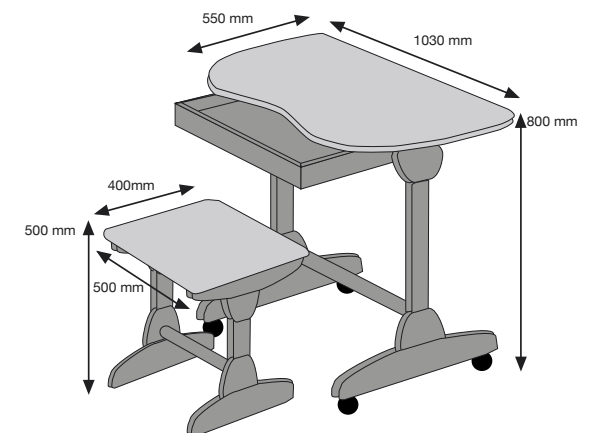

## LINEA VOYAGER

### POSTAZIONI TRUCCO TRASPORTABILI

Valigie di produzione Italiana, con scocche di ABS realizzate in termoformatura, linee arrotondate design accattivante, ampio maniglione in alluminio, gambe telescopiche incorporate. Disponibile in due modelli.

- ▶ RESISTENZA & LEGGEREZZA
- ▶ TRASPORTABILITÀ
- ▶ DI FACILE PULIZIA
- ▶ ILLUMINAZIONE PROFESSIONALE PER MAKE UP\*\*

TECNOLOGIA **I-LIGHT** PER UNA LUCE PERFETTA GLI SPECIALI CUPOLINI DIFFONDONO UNA LUCE RADIOSA ED AVVOLGENTE, con una resa costante nel tempo

- VERSIONE DIMMER: regolazione intensità progressiva
- VERSIONE ON/OFF: nessuna regolazione
- BASSO CONSUMO
- LUNGA DURATA
- ALTO LIVELLO DI SICUREZZA

- ▶ GARANZIA 2 ANNI & CERTIFICAZIONE CE

Caratteristica fondamentale delle POSTAZIONI CANTONI è l'estrema facilità e velocità in apertura e in chiusura, le gambette telescopiche sono incorporate e non si devono agganciare separatamente.

Durante il trasporto, o quando è necessario riporle, queste postazioni si trasformano in una valigia estremamente COMPATTA e MANEGGEVOLE, poiché formata da un corpo unico.



## VOYAGER LINE

### PORTABLE MAKE UP STATIONS

Italian handmade production, these items are composed by ABS moulded shells with rounded shape and charming design. Provided with integrated Telescopic Stands and incorporated trolley, large aluminium handle. Available in 2 models.

- ▶ DURABILITY & LIGHTNESS
- ▶ PORTABILITY
- ▶ EASY TO CLEAN
- ▶ PROFESSIONAL LIGHTING EXPRESSLY DESIGNED FOR MAKE UP\*\*

THE **I-LIGHT** TECHNOLOGY SYSTEM CREATES A PERFECT ILLUMINATION, THE CAPS DIFFUSE THE LIGHT, and maintain a constant over time performance

- DIMMER VERSION: Adjustable intensity of the light
- ON/OFF VERSION: no regulation
- LOW POWER CONSUMPTION
- LONG LIFE
- HIGH LEVEL OF SAFETY STANDARDS

- ▶ 2 YEAR WARRANTY & CE CERTIFICATION

During the transport, or when it is necessary to put it back, this station transforms quickly into a very COMPACT and MANAGEABLE suitcase, since it is formed by a unique body. Essential characteristic of the CANTONI STATIONS is the extreme simplicity and smartness when opening and closing the station, as the telescopic stands are incorporated so they don't need to be screwed to the structure.



# ART. VOSL.TR-10



Dotata di vassoi scorrevoli a chiusura magnetica del contenitore, cassetto laterale scorrevole a chiusura magnetica, inserito nel corpo valigia. Ampio specchio illuminato e presa di corrente.

## POSTAZIONE FISSA

Profumerie, saloni, backstage



Istituti di bellezza, parrucchieri



Accademie



Vetrine



## POSTAZIONE MOBILE

Trucco a domicilio



Set cinematografici in esterno



Internally equipped with a container provided of several compartments, the bigger one has 2 sliding trays, with magnetic locks, which function as support base during make up performance.

Lateral sliding drawer, secured with magnetic key lock, enclosed in the suitcase body. Wide illuminated mirror with I-LIGHT technology system 6 spot light, socket..

Recommended for:

## IN PLACE

Perfumeries, salons, fashion backstage



Beauty institutes, SPA, hairdressers



Make up academies



Point of sale, visual merchandising



## ON THE MOVE

Wedding & home services



Movie backstages



ACCESSORI - ACCESSORIES



**COVER**

Borsa portavaligia in tessuto tecnico, imbottita, per protezione contro gli urti durante il trasporto.



**COVER**

Shockproof protection bag in softpadded fabric material.

**LEGGIO**

Molto utile per avere i progetti sempre visibili. Possibilità di abbinarlo anche alle valigie in fase di ordine delle stesse.



**BOOKREST**

Very useful to place projects. It is possible to require this accessory combined with our portable make up stations exclusively when ordering them.



SCHEDA TECNICA - TECHNICAL DETAIL

| Modello<br>Model | A<br>mm | B<br>mm | C<br>mm | D<br>mm | E<br>mm |         |
|------------------|---------|---------|---------|---------|---------|---------|
| VOYS L.TR-10     | 640     | 560     | 265     | 70      | 195     | 15,8 kg |

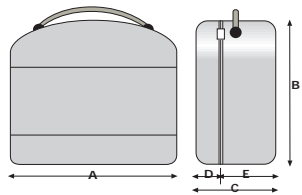

Altezza piano di lavoro:  
970 mm con estensione  
massima delle gambe  
telescopiche.  
Table top height:  
970 mm  
(max extension)

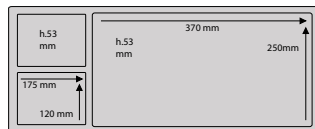
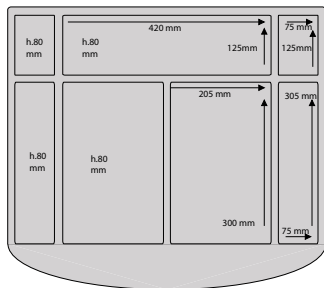

cass.laterale - lateral drawer





La versione più piccola della linea.  
Dotata di vassoi scorrevoli a chiusura magnetica del contenitore.  
Ampio specchio illuminato e presa di corrente.

POSTAZIONE FISSA

- Profumerie, saloni, backstage ●●
- Istituti di bellezza, parrucchieri ●●
- Accademie ●●●
- Vetrine ●●

POSTAZIONE MOBILE

- Trucco a domicilio ●●●●●
- Set cinematografici in esterno ●●●●



This is the smallest of the line. Inner container provided of several compartments, the bigger one has 2 sliding trays, with magnetic locks, which functions as support base during make up performance. Wide illuminated mirror with I-LIGHT technology system 6 spot light, socket.

Recommended for:

IN PLACE

- Perfumeries, salons, fashion backstage ●●
- Beauty institutes, SPA, hairdressers ●●
- Make up academies ●●●
- Point of sale, visual merchandising ●●

ON THE MOVE

- Wedding & home services ●●●●●
- Movie backstages ●●●●



ACCESSORI - ACCESSORIES



**COVER**

Borsa portavaligia in tessuto tecnico, imbottita, per protezione contro gli urti durante il trasporto.



**LEGGIO**

Molto utile per avere i progetti sempre visibili. Possibilità di abbinarlo anche alle valigie in fase di ordine delle stesse.



**COVER**

Shockproof protection bag in softpadded fabric material.

**BOOKREST**

Very useful to place projects. It is possible to require this accessory combined with our portable make up stations exclusively when ordering them.



SCHEDA TECNICA - TECHNICAL DETAIL

| Modello<br>Model       | A<br>mm | B<br>mm | C<br>mm | D<br>mm | E<br>mm |       |
|------------------------|---------|---------|---------|---------|---------|-------|
| VOYS L.<br>SLIM. TR-10 | 640     | 560     | 200     | 70      | 130     | 13 kg |

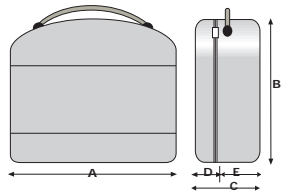

Altezza piano di lavoro:  
920 mm con estensione  
massima delle gambe  
telescopiche.  
Table top height:  
920 mm  
(max extension)

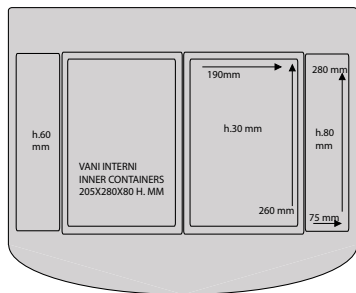

## LINEA WORKSTATION

### POSTAZIONI TRUCCO SU RUOTE

Produzione artigianale Italiana di alta gamma, in faggio laccato a mano, specchio basculante e regolabile in altezza, piano di appoggio, ripiano di servizio, cassetti.

- ▶ SOLIDITÀ E CURA DEI DETTAGLI
- ▶ VERSATILITÀ E COMODITÀ
- ▶ ORDINE & PRATICITÀ
- ▶ ILLUMINAZIONE PROFESSIONALE PER MAKE UP\*\*

TECNOLOGIA I-LIGHT PER UNA LUCE PERFETTA GLI SPECIALI CUPOLINI DIFFONDONO UNA LUCE RADIOSA ED AVVOLGENTE, con una resa costante nel tempo

- VERSIONE DIMMER: regolazione intensità progressiva
- VERSIONE ON/OFF: nessuna regolazione
- BASSO CONSUMO
- LUNGA DURATA
- ALTO LIVELLO DI SICUREZZA

- ▶ GARANZIA 2 ANNI & CERTIFICAZIONE CE



## WORKSTATION LINE

### MOVABLE MAKE UP STATIONS

Italian handmade high grade production, made of hand-lacquered beechwood, pivoting mirror adjustable at different heights, worktop, additional shelf, drawers.

- ▶ ROBUSTNESS & ATTENTION TO DETAILS
- ▶ ADAPTABLE & COMFORTABLE
- ▶ ORDER & PRACTICALITY
- ▶ PROFESSIONAL LIGHTING EXPRESSEDLY DESIGNED FOR MAKE UP\*\*

THE I-LIGHT TECHNOLOGY SYSTEM CREATES A PERFECT ILLUMINATION, THE CAPS DIFFUSE THE LIGHT, and maintain a constant over time performance

- DIMMER VERSION: Adjustable intensity of the light
- ON/OFF VERSION: no regulation
- LOW POWER CONSUMPTION
- LONG LIFE
- HIGH LEVEL OF SAFETY STANDARDS

- ▶ 2 YEAR WARRANTY & CE CERTIFICATION





# ART. L400 - L400X2



Postazione trucco su ruote.  
Dotata di specchio regolabile in altezza,  
con illuminazione I-LIGHT e presa  
di corrente; comodo piano di appoggio con  
4 cassetti ad apertura laterale, un ripiano  
di servizio; bicchieri porta pennelli  
agganciabili ai supporti laterali ed un  
"leggio" dove posizionare progetti.

Fornita anche nella versione con  
specchio su entrambi i lati - L400X2

Colori disponibili: Nero.  
Su richiesta colori personalizzati.

## POSTAZIONE FISSA

- Profumerie, saloni,  
backstage ● ● ●
- Istituti di bellezza,  
parrucchieri ● ● ● ●
- Accademie ● ● ● ● ●
- Vetrine ● ● ●



Moveable make up station, provided of  
support base, 4 lateral drawers, 1 shelf,  
2 plastic glasses for brushes and pencils  
hooked up to the lateral pillars,  
1 bookrest where to place your sketches.  
Wide illuminated mirror, with different  
adjustable heights, I-LIGHT technology  
system and 6 spot light, socket.

The version with double mirror - L400X2

Available color: Black.  
Customized colors on request.

Recommended for:

## IN PLACE

- Perfumeries, salons,  
fashion backstage ● ● ●
- Beauty institutes,  
SPA, hairdressers ● ● ● ●
- Make up academies ● ● ● ● ●
- Point of sale, visual  
merchandising ● ● ●

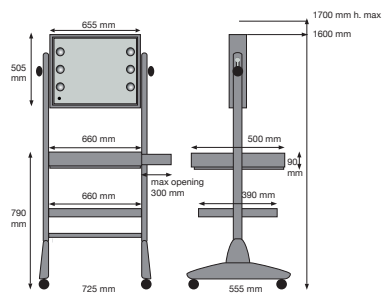

L400.N-10 FO  
FULL MIRROR



**OPZIONI DISPONIBILI**

Entrambe le versioni possono essere richieste:

- I-LIGHT CANTONI\*\* TUTTO SPECCHIO  
la più prestigiosa e di grande effetto scenico
- I-LIGHT CANTONI\*\* SPECCHIO INCORNICIATO

\*\*BREVETTO EUROPEO

**OPTIONS**

Both versions are available as follow:

- I-LIGHT technology system FULL MIRROR LED\*\*
- I-LIGHT technology system MIRROR FRAME\*\*

\*\*EU PATENT

**ACCESSORI - ACCESSORIES**



**LEGGIO**

Molto utile per avere i progetti sempre visibili.

**BICCHIERI**

Porta pennelli o matite, sempre in ordine e a portata di mano.



**BOOKREST** very useful to place projects.

**BRUSH HOLDERS**  
(included).



L400.N-10 FO  
MIRROR FRAME



## ART. L200 - L200X2



Postazione trucco su ruote.

Dotata di specchio regolabile in altezza, con illuminazione I-LIGHT e presa di corrente; comodo piano di appoggio con 1 cassetto centrale, a scorrimento su entrambi i lati, un ripiano di servizio; bicchieri porta pennelli agganciabili ai supporti laterali ed un "leggio" dove posizionare progetti, questa postazione è completa e funzionale, comoda sia per il truccatore che per la cliente.

Fornita anche nella versione con specchio su entrambi i lati - L200X2.

Colori disponibili: Nero.

Su richiesta colori personalizzati.

### POSTAZIONE FISSA

Profumerie, saloni,  
backstage



Istituti di bellezza,  
parrucchieri



Accademie



Vetrine



Moveable make up station, provided of support base, 1 frontal drawer, 1 shelf, 2 plastic glasses for brushes and pencils hooked up to the lateral pillars, 1 bookrest where to place your sketches. Wide illuminated mirror, with different adjustable heights, I-LIGHT technology system and 6 spot light, socket.

The version with double mirror - L200X2

Available color: Black.

Customized colors on request.

Recommended for:

### IN PLACE

Perfumeries, salons,  
fashion backstage



Beauty institutes,  
SPA, hairdressers



Make up academies



Point of sale, visual  
merchandising

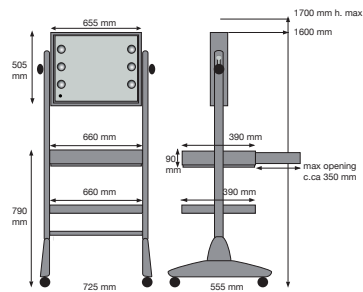

**OPZIONI DISPONIBILI**

Entrambe le versioni possono essere richieste:

- I-LIGHT CANTONI\*\* TUTTO SPECCHIO  
la più prestigiosa e di grande effetto scenico
- I-LIGHT CANTONI\*\* SPECCHIO INCORNICIATO

\*\*BREVETTO EUROPEO

**OPTIONS**

Both versions are available as follow:

- I-LIGHT technology system FULL MIRROR LED\*\*
- I-LIGHT technology system MIRROR FRAME\*\*

\*\*EU PATENT

**ACCESSORI - ACCESSORIES**



**LEGGIO**

Molto utile per avere i progetti sempre visibili.

**BICCHIERI**

Porta pennelli o matite, sempre in ordine e a portata di mano.



**BOOKREST** very useful to place projects.

**BRUSH HOLDERS**  
(included).

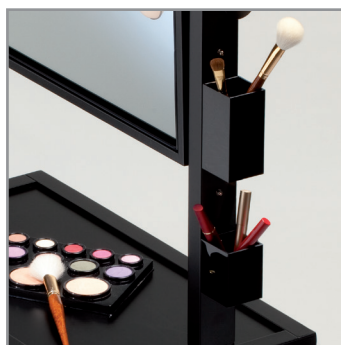

L200.N-10 FO  
MIRROR FRAME





Fornita anche nella versione con specchio su entrambi i lati  
L400X2 - L200X2  
per ottenere una doppia postazione con la quale possono operare 4 persone.

Molto comoda per le scuole che con questa soluzione possono sfruttare al massimo lo spazio disponibile.



The version with double mirror, L400X2 - L200X2 one for each side, serves 4 people together.

It is very useful for schools to make better use of the room space.



L400.X2.N-10 FO



L200.X2.N-10 FO FULL MIRROR LED & LCS

## ACCESSORI - ACCESSORIES



LCN

### CARRELLO DI SERVIZIO

Comodo carrello a 2 ripiani, contenitore in ABS con divisori regolabili. Molto utile in abbinamento alle postazioni per alloggiare strumenti e prodotti aggiuntivi, sempre in ordine e a portata di mano. In legno laccato, contenitori estraibili, ruote girevoli.



LCN

### WHEELED DOLLY

Laquered wood dolly, 2 shelves with ABS trays including adjustable dividers. Very useful combined with the workstation to store whatever necessary, and keep it always clean and tidy.



L200.B-10 FO FULL MIRROR LED  
& LCB



## LINEA SEDIE PROFESSIONALI

### SEDIE TRUCCO TRASPORTABILI

Sedie professionali per Make up ed Estetica, produzione artigianale Italiana, pieghevoli e trasportabili, in faggio laccato a mano o alluminio anodizzato, finiture in acciaio, poggipiedi con gomma antiscivolo.

- ▶ SOLIDITÀ E CURA DEI DETTAGLI
- ▶ COMODITÀ DI UTILIZZO
- ▶ LUNGA DURATA
- ▶ TRASPORTABILITÀ
- ▶ ALTO LIVELLO DI SICUREZZA
- ▶ ACCESSORI DEDICATI

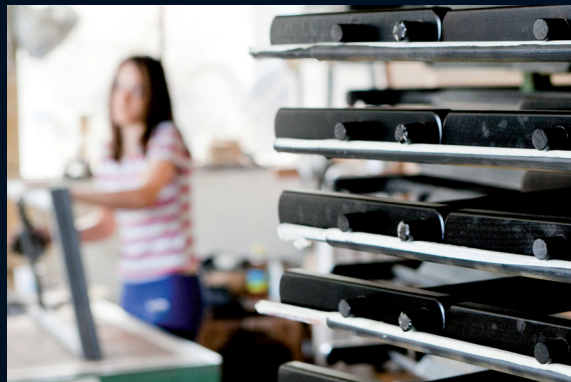

## PROFESSIONAL CHAIRS LINE

### PORTABLE MAKE UP CHAIRS

Professional chairs for makeup and aesthetic sectors, Italian handmade production. Foldable and portable, made of hand-laquered beechwood or anodized aluminium, with steel finishings, slip-resistant footrest.

- ▶ ROBUSTNESS & ATTENTION TO DETAILS
- ▶ DESIGN & COMFORT
- ▶ LONG LASTING
- ▶ PORTABILITY
- ▶ HIGH LEVEL OF SAFETY STANDARDS
- ▶ SPECIFIC ACCESSORIES



L'ergonomia, secondo la I.E.A. (International Ergonomics Association), è quella scienza che si occupa dell'interazione tra gli elementi di un sistema (umani e d'altro tipo) e la funzione per cui vengono progettati (nonché la teoria, i principi, i dati e i metodi che vengono applicati nella progettazione), allo scopo di migliorare la soddisfazione dell'utente e l'insieme delle prestazioni del sistema. In pratica è quella scienza che si occupa dello studio dell'interazione tra individui e tecnologie.

L'ergonomia cerca quindi di individuare i parametri più importanti per il corretto rapporto uomo/lavoro, per eliminare i fattori negativi che possono essere presenti e rendere quindi più facile e naturale l'utilizzo degli oggetti di lavoro.

“Un sedile da lavoro” ergonomico deve essere stabile, deve permettere all'utilizzatore una certa libertà di movimento ed una posizione comoda, deve avere dimensioni adatte alla persona che lo deve utilizzare, deve essere solido, sicuro, regolabile e dimensionato, confortevole e pratico. Deve permettere di mantenere la schiena eretta.



**LE SEDIE E IL POGGIATESTA  
CANTONI  
SEPPUR TRASPORTABILI  
RISPONDONO  
AGLI STANDARD  
DI ERGONOMIA**

Human factors and ergonomics is employed to fulfill the goals of health and safety and productivity. It is relevant in the design of such things as safe furniture and easy-to-use interfaces to machines and equipment. Proper ergonomic design is necessary to prevent repetitive strain injuries and other musculoskeletal disorders, which can develop over time and can lead to long-term disability.

- Adjustability - Check to see that seat height is adjustable.
- Seat height range - Check whether the seat height can be adjusted to the height recommended for the worker(s) who will use it. Other chairs may have to be selected for very short or tall workers.
- Backrest - Check to see that the backrest is adjustable both vertically and in the frontward and backward direction.
- Seat depth - Select the seats that suit the tallest and the shortest users
- Stability - Check for the stability of the chair

**THE CHAIRS  
AND THE HEADRESTS  
CANTONI  
EVEN IF TRANSPORTABLE  
MEET THE REQUIREMENTS  
IN COMPLIANCE OF  
ERGONOMICS STANDARDS**



## SEDIA MAKE UP IN LEGNO A DOPPIA ALTEZZA

Regolazione a 2 altezze, permette di lavorare sempre in posizione corretta. Seduta e schienale in PVC facilmente lavabile.

COLORI DISPONIBILI: nero e bianco. Su richiesta colori personalizzati.

## ART. S102.N



## WOOD MAKE UP CHAIR DOUBLE HEIGHT

Professional make up chair, double height regulation to always work in correct position. Sitting and back in PVC easy to clean.

Available colors: black, white, nat wood. On request custom colors.



### ACCESSORI - ACCESSORIES



#### B02 - B02.TR

Sacca per il trasporto in tessuto tecnico, imbottita per protezione contro gli urti, versione con o senza trolley.

**B03 borsa portaoggetti** - da posizionare sul bracciolo o indossata come cintura.

**KH portakleenex** - agganciabile al poggiatesta per salviette sempre disponibili.

#### HR SYSTEM - POGGIATESTA **\*\* BREVETTO EUROPEO**

Si aggancia alla sedia, è regolabile in altezza ed è reclinabile, queste regolazioni permettono un utilizzo estremamente personalizzato in base alle più svariate esigenze, dotato di un sistema di bloccaggio facile e veloce. **L'unico poggiatesta trasportabile che mantiene le caratteristiche di comodità e funzionalità di quelli fissi.** Dotato di sacca per il trasporto. Molto utile per sedute di make up e trattamenti viso.



#### B02 TRAVEL BAG - B02.TR TRAVEL BAG WITH TROLLEY

Travel bag in strong and padded fabric material. Useful to keep safe and carry the chair.

#### B03 ACCESSORY BAG

Can be hanged to the arm of the chair or worn as a belt.

#### KH KLEENEX HOLDER

Can be hanged on the structure of headrest to have always tissues at hand.

#### HR SYSTEM - HEADREST **\*\* EU PATENTED**

For make up and skin care treatments, can be applied to the chair.

This ergonomic headrest can be adjusted in height and it is tilting, thanks to a special mechanism.

It grants the maximum comfort both for the clients and professionals. The unique portable head rest with the comfort and functionality necessary for a correct work. With transport bag.



B02.TR



HR SYSTEM



SACCA HR SYSTEM  
COVER HR SYSTEM

S102.N



ART. S102.N

S102.B



 7,5 kg

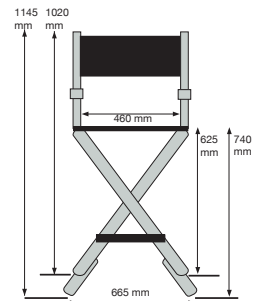

THE ORIGINAL ONE

[www.cantonionline.com](http://www.cantonionline.com)

MADE IN ITALY





## SEDIA MAKE UP IN LEGNO

Questo modello si caratterizza per la linea originale. È comoda ed ergonomica, ha la struttura bilanciata antiribaltamento, seduta e schienale imbottiti.

COLORI DISPONIBILI: nero. Su richiesta colori personalizzati.

## ART. S104



## WOOD MAKE UP CHAIR - TIP PROOF

This model has an impressive design, it is very comfortable and ergonomic, it is well balanced and proof against overturn. Sitting and back in padded leatherette.

Available colors: black. On request custom colors.



### ACCESSORI - ACCESSORIES



#### B02L

Sacca per il trasporto in tessuto tecnico, imbottita per protezione contro gli urti.

**B03 borsa portaoggetti** - da posizionare sul bracciolo o indossata come cintura.

**KH portakleenex** - agganciabile al poggiatesta per salviette sempre disponibili.

#### HR SYSTEM - POGGIATESTA \*\* BREVETTO EUROPEO

Si aggancia alla sedia, è regolabile in altezza ed è reclinabile, queste regolazioni permettono un utilizzo estremamente personalizzato in base alle più svariate esigenze, dotato di un sistema di bloccaggio facile e veloce. L'unico poggiatesta trasportabile che mantiene le caratteristiche di comodità e funzionalità di quelli fissi. Dotato di sacca per il trasporto. Molto utile per sedute di make up e trattamenti viso.



#### B02L TRAVEL BAG

Travel bag in strong and padded fabric material.

Useful to keep safe and carry the chair.

#### B03 ACCESSORY BAG

Can be hung to the arm of the chair or worn as a belt.

#### KH KLEENEX HOLDER

Can be hanged on the structure of headrest to have always tissues at hand.

#### HR SYSTEM - HEADREST \*\* EU PATENTED

For make up and skin care treatments, can be applied to the chair.

This ergonomic headrest can be adjusted in height and it is tilting, thanks to a special mechanism.

It grants the maximum comfort both for the clients and professionals. The unique portable head rest with the comfort and functionality necessary for a correct work. With transport bag.



B02.L



HR SYSTEM



SACCA HR SYSTEM  
COVER HR SYSTEM

ART. S104



 8,5 kg

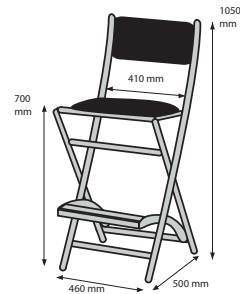

THE ORIGINAL ONE

[www.cantonionline.com](http://www.cantonionline.com)

MADE IN ITALY





## SEDIA MAKE UP IN ALLUMINIO

questo nuovo modello ha una struttura in alluminio e finiture in legno  
seduta e schienale imbottiti, braccioli.  
leggera e richiudibile per un facile trasporto  
si caratterizza per il design originale e per la stabilità

## ART. S105.A



## ALUMINIUM MAKE UP CHAIR

this new model has an aluminium structure with wood finishings, sitting and back  
in padded leatherette, armrest.  
light and foldable for an easy transport, it is very comfortable and ergonomic,  
well balanced to grant stability  
very impressive design



46

CE

### ACCESSORI - ACCESSORIES



**HR SYSTEM - POGGIATESTA \*\* BREVETTO EUROPEO**  
Si aggancia alla sedia, è regolabile in altezza ed è reclinabile,  
queste regolazioni permettono un utilizzo estremamente  
personalizzato in base alle più svariate esigenze, dotato di  
un sistema di bloccaggio facile e veloce. L'unico poggiatesta  
trasportabile che mantiene le caratteristiche di comodità e  
funzionalità di quelli fissi. Dotato di sacca per il trasporto.  
Molto utile per sedute di make up e trattamenti viso.



**HR SYSTEM - HEADREST \*\* EU PATENTED**  
For make up and skin care treatments,  
can be applied to the chair.  
This ergonomic headrest can be adjusted  
in height and it is tilting, thanks to a special  
mechanism.  
It grants the maximum comfort both for the  
clients and professionals. The unique portable  
head rest with the comfort and functionality  
necessary for a correct work.  
With transport bag.



HR SYSTEM



SACCA HR SYSTEM  
COVER HR SYSTEM

ART. S105.A



 8,5 kg

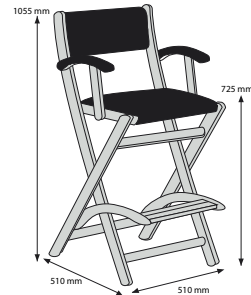

THE ORIGINAL ONE

[www.cantonionline.com](http://www.cantonionline.com)

MADE IN ITALY





## SEDIA MAKE UP IN ALLUMINIO

Estremamente leggera e maneggevole. È consigliata per spostamenti frequenti.

COLORI DISPONIBILI: nero, bianco, alluminio naturale.

## ART. S102.A



## ALUMINIUM MAKE UP CHAIR

Extremely light and handy, it is recommended for frequent moves.  
Sitting and back in PVC.

Available colors: black, white, silver.



S102.A

### ACCESSORI - ACCESSORIES



#### B02.A - B02.A TR

Sacca per il trasporto in tessuto tecnico, imbottita per protezione contro gli urti, versione con o senza trolley.

**B03 borsa portaoggetti** - da posizionare sul bracciolo o indossata come cintura.

**KH portakleenex** - agganciabile al poggiatesta per salviette sempre disponibili.

#### HR SYSTEM - POGGIATESTA \*\* BREVETTO EUROPEO

Si aggancia alla sedia, è regolabile in altezza ed è reclinabile, queste regolazioni permettono un utilizzo estremamente personalizzato in base alle più svariate esigenze, dotato di un sistema di bloccaggio facile e veloce. **L'unico poggiatesta trasportabile che mantiene le caratteristiche di comodità e funzionalità di quelli fissi.** Dotato di sacca per il trasporto. Molto utile per sedute di make up e trattamenti viso.



B02.A TR



#### B02.A TRAVEL BAG - B02.A TR TRAVEL BAG WITH TROLLEY

Travel bag in strong and padded fabric material. Useful to keep safe and carry the chair.

#### B03 ACCESSORY BAG

Can be hung to the arm of the chair or worn as a belt.

#### KH KLEENEX HOLDER

Can be hung on the structure of headrest to have always tissues at hand.

#### HR SYSTEM - HEADREST \*\* EU PATENTED

For make up and skin care treatments, can be applied to the chair. This ergonomic headrest can be adjusted in height and it is tilting, thanks to a special mechanism.

It grants the maximum comfort both for the clients and professionals. The unique portable head rest with the comfort and functionality necessary for a correct work. With transport bag.



HR SYSTEM



SACCA HR SYSTEM  
COVER HR SYSTEM



S102.A.N



# ART. S102.A

S102.A.B



 5 kg

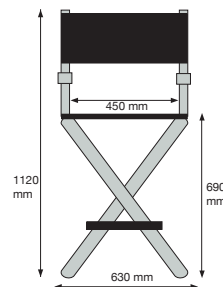

THE ORIGINAL ONE

[www.cantonionline.com](http://www.cantonionline.com)

MADE IN ITALY





## SEDIA MAKE UP IN ALLUMINIO DOPPIA ALTEZZA

Estremamente leggera e maneggevole. È consigliata per spostamenti frequenti.

COLORI DISPONIBILI: nero, bianco, alluminio naturale.



## ALUMINIUM MAKE UP CHAIR DOUBLE HEIGHT

Extremely light and handy, it is recommended for frequent moves.  
Sitting and back in PVC.

Available colors: black, white, silver.



50

### ACCESSORI - ACCESSORIES



#### B02 - B02.TR

Sacca per il trasporto in tessuto tecnico, imbottita per protezione contro gli urti, versione con o senza trolley.

**B03 borsa portaoggetti** - da posizionare sul bracciolo o indossata come cintura.

**KH portakleenex** - agganciabile al poggiatesta per salviette sempre disponibili.

#### HR SYSTEM - POGGIATESTA \*\* BREVETTO EUROPEO

Si aggancia alla sedia, è regolabile in altezza ed è reclinabile, queste regolazioni permettono un utilizzo estremamente personalizzato in base alle più svariate esigenze, dotato di un sistema di bloccaggio facile e veloce. L'unico poggiatesta trasportabile che mantiene le caratteristiche di comodità e funzionalità di quelli fissi. Dotato di sacca per il trasporto. Molto utile per sedute di make up e trattamenti viso.



B02.A TR



#### B02 TRAVEL BAG - B02.TR TRAVEL BAG WITH TROLLEY

Travel bag in strong and padded fabric material. Useful to keep safe and carry the chair.

#### B03 ACCESSORY BAG

Can be hung to the arm of the chair or worn as a belt.

#### KH KLEENEX HOLDER

Can be hung on the structure of headrest to have always tissues at hand.

#### HR SYSTEM - HEADREST \*\* EU PATENTED

For make up and skin care treatments, can be applied to the chair.

This ergonomic headrest can be adjusted in height and it is tilting, thanks to a special mechanism.

It grants the maximum comfort both for the clients and professionals. The unique portable head rest with the comfort and functionality necessary for a correct work.  
With transport bag.



HR SYSTEM



SACCA HR SYSTEM  
COVER HR SYSTEM



THE ORIGINAL ONE

www.cantonionline.com

MADE IN ITALY

ART. S102.A 2H



 6 kg

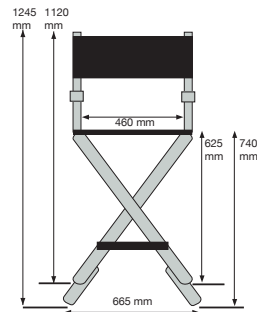

THE ORIGINAL ONE

[www.cantonionline.com](http://www.cantonionline.com)

MADE IN ITALY



## LINEA MIRROR

Linea di specchi da tavolo, da muro, Sistemi Modulari. Permettono di creare soluzioni personalizzate con minimo ingombro. Realizzati in materiali pregiati quali legno laccato a mano o METACRILATO LUCIDO, in stile moderno e ricercato si adattano a qualunque arredamento.

- ▶ VERSATILITÀ
- ▶ DESIGN
- ▶ ILLUMINAZIONE PROFESSIONALE PER MAKE UP\*\*

TECNOLOGIA I-LIGHT PER UNA LUCE PERFETTA GLI SPECIALI CUPOLINI DIFFONDONO UNA LUCE RADIOSA ED AVVOLGENTE, con una resa costante nel tempo

- VERSIONE DIMMER: regolazione intensità progressiva
  - VERSIONE ON/OFF: nessuna regolazione
  - BASSO CONSUMO
  - LUNGA DURATA
  - ALTO LIVELLO DI SICUREZZA
- ▶ GARANZIA 2 ANNI & CERTIFICAZIONE CE



## MIRROR LINE

This line consists of Table Mirrors, Wall Mirrors, Modular System. It is possible to combine personalized solutions in minimal space. Made out with fine materials such as Hand-laquered beechwood or Shiny acrylic (metacrilato). The modern and refined design suits with any interior decorating solutions.

- ▶ VERSATILITY
- ▶ DESIGN
- ▶ PROFESSIONAL LIGHTING EXPRESSLY DESIGNED FOR MAKE UP\*\*

THE I-LIGHT TECHNOLOGY SYSTEM CREATES A PERFECT ILLUMINATION, THE CAPS DIFFUSE THE LIGHT, and maintain a constant over time performance

- DIMMER VERSION: Adjustable intensity of the light
  - ON/OFF VERSION: no regulation
  - LOW POWER CONSUMPTION
  - LONG LIFE
  - HIGH LEVEL OF SAFETY STANDARDS
- ▶ 2 YEAR WARRANTY & CE CERTIFICATION





## MAKE UP CORNER STAND ALONE

Postazione per il make up a sistema modulare. Può essere posizionata ovunque, si compone di uno specchio con illuminazione I-LIGHT a 9 punti luce e pulsante di accensione, un tavolo di appoggio, base e pilone. Tutti i componenti si agganciano ad un pilone in alluminio dotato di una base che ne garantisce la stabilità.

Il materiale di METACRILATO lucido, è prestigioso e ha un impatto altamente scenografico, i colori standard sono BIANCO, NERO E SILVER.



## MAKE UP CORNER STAND ALONE

Modular make up corner. It can be positioned everywhere, it is composed of 1 mirror with I-LIGHT Technology system, 9 spot light and a rounded table hooked up to an aluminium reed kept steady by a solid base.

The Shiny acrylic (metacrilato) material makes this corner very impressive. The standard colors are: white, black and silver.

### ACCESSORI - ACCESSORIES



**BARRA PORTA INSEGNA** 03122/90 e 03122/45  
Nella versione da 900 o 450 mm

CESTINO CP63 + CP93 (Top)



**SIGN HOLDER BAR** 03122/90 & 03122/45  
900 or 450 mm long version

WASTE BIN CP63 + CP93 (Top)



CP63 + CP93

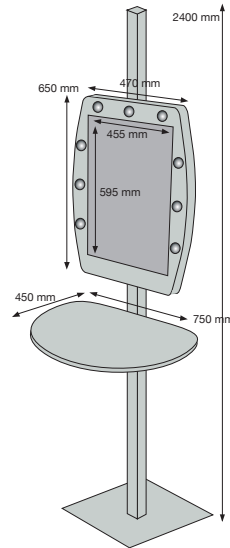

MCR.W



MCR.S



MCR.B

THE ORIGINAL ONE

[www.cantonionline.com](http://www.cantonionline.com)

MADE IN ITALY





### MAKE UP CORNER WALL MOUNT

Postazione posizionabile a muro, si compone di uno specchio con illuminazione I-LIGHT a 9 punti luce e pulsante di accensione, un piano di appoggio con contenitore e vassoi scorrevoli dove poter alloggiare tutti i prodotti e gli strumenti necessari. Doppio fondo utilizzabile come magazzino.

Materiale in METACRILATO lucido.  
Colore NERO.



### MAKE UP CORNER WALL MOUNT

Make up station to be positioned on the wall, it is composed of 1 mirror with I-LIGHT Technology system, and 9 spot lights, a capacious container with sliding trays on a support base where to place all tools and instruments including a false bottom to store provisions.

Shiny acrylic (metacrilato) material.  
Color: black.







MAKE UP CORNER STAND ALONE

Postazione make up a sistema modulare, può essere posizionata ovunque si compone di uno specchio con illuminazione I-LIGHT a 9 punti luce e pulsante di accensione, un piano di appoggio con contenitore e vassoi scorrevoli dove poter alloggiare tutti i prodotti e gli strumenti necessari.

Doppio fondo utilizzabile come magazzino. base e pilone.

Tutti i componenti si agganciano ad un pilone in alluminio con base che ne garantisce la stabilità

Materiale in METACRILATO lucido.

Colore: nero, silver



MAKE UP CORNER STAND ALONE

Modular make up corner can be positioned everywhere, it is composed of 1 mirror with I-LIGHT Technology system, 9 spot lights, a capacious container with sliding trays on a support base where to place all tools and instruments including a false bottom to store provisions. hooked up to an aluminum reed column kept steady by a solid base

Shiny acrylic (metacrilato) material.

Color: black.

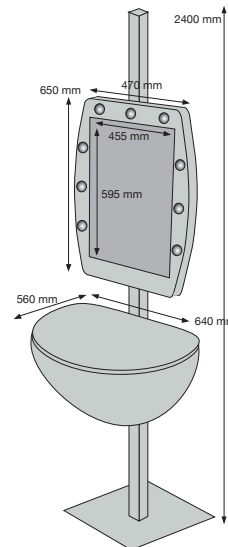

CE CE Certification - 220V & 110V - for EU and US standard

NEW



# ART. MDW



MDW

Specchio con attacco a muro, in METACRILATO lucido, illuminazione I-LIGHT a 9 punti luce e pulsante di accensione.

Colori disponibili: Nero, Bianco, Silver.



MDW

Make up mirror, wall mount.  
Shiny acrylic (metacrilato) material, with I-LIGHT Technology system, 9 spot light.

Available colors: black, white, silver.

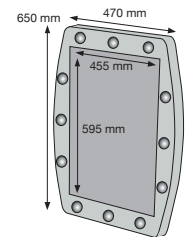

## ART. MDW



### MDW.s

Specchio da muro, con braccio snodabile, in METACRILATO lucido, illuminazione I-LIGHT a 12 punti luce e pulsante di accensione posizionato sul retro. Il braccio snodabile permette di posizionare lo specchio in diverse posizioni, per un controllo accurato del lavoro.

Colori disponibili: Nero, Bianco, Silver.

**CE** CE Certification - 220V & 110V - for EU and US standard

## ART. MDW.s



### MDW.s

Mirror with wall bracket, can be rotated in any direction to have an accurate control of the light during make up. Shiny acrylic (metacrilato) material, with I-LIGHT Technology system, 12 spot light.

Available colors: black, white, silver.

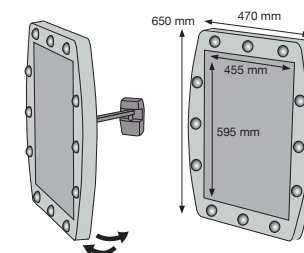

## ART. MW01.TSK



LEGGERO, MANEGGEVOLE, SICURO  
SI PORTA DAPPERTUTTO!

LIGHT, HANDY, TRUSTY  
IT CAN BE CARRIED EVERYWHERE!



MW01.TSK

Specchio multifunzione, estremamente versatile.

Trasportabile e leggero

si può posizionare su tavolo o a muro, grazie al meccanismo di supporto di cui è dotato.



MW01.TSK

Portable mirror, all-in-one.

Light and easy to transport,

Can be positioned on a table or hunged to a wall, thanks to the special mechanism incorporated TRUSTY

## ART. MW01.TSK



MW01.TSK

Gli speciali cupolini diffondono la luce con un effetto avvolgente.



MW01.TSK

I-LIGHT Technology system creates a perfect illumination the caps diffuse the light with bright, fascinating and embracing effect.

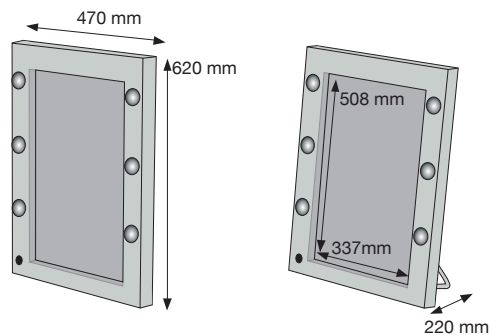

Fornita di sacca imbottita per un trasporto facile e sicuro

Provided with carrying padded bag for a safety and easy transport



## ART. MDT.S



Specchio da tavolo in METACRILATO lucido, illuminazione I-LIGHT con 12 punti luce e pulsante di accensione.

Colori disponibili: Nero, Bianco, Silver.



62  CE Certification - 220V & 110V - for EU and US standard



THE ORIGINAL ONE

[www.cantonionline.com](http://www.cantonionline.com)

MADE IN ITALY

## ART. MDT.B



Desk mirror. Shiny acrylic (metacrilato) material, with I-LIGHT Technology system, 12 spot light.

Available colors: black, white, silver.

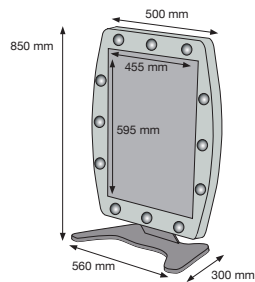

CE CE Certification - 220V & 110V - for EU and US standard

63

## ART. MDT.N



Specchio da tavolo in METACRILATO lucido,  
illuminazione I-LIGHT con 12 punti luce e pulsante di accensione.

Colori disponibili: Nero, Bianco, Silver.



Desk mirror. Shiny acrylic (metacrilato) material, with I-LIGHT  
Technology system, 12 spot light.

Available colors: black, white, silver.

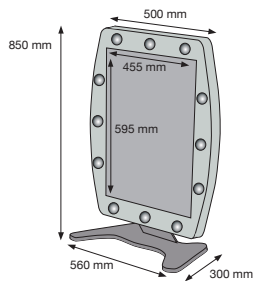

64  CE Certification - 220V & 110V - for EU and US standard



THE ORIGINAL ONE

[www.cantononline.com](http://www.cantononline.com)

MADE IN ITALY



## ART. MW01.T



Specchio da tavolo in METACRILATO lucido, illuminazione I-LIGHT con 6 punti luce e pulsante di accensione.

Colore Silver. Ulteriori colori disponibili su richiesta.



Desk mirror. Shiny acrylic (metacrilato) material, with I-LIGHT Tecnology system, 6 spot light.

Color: silver. On request custom colors.

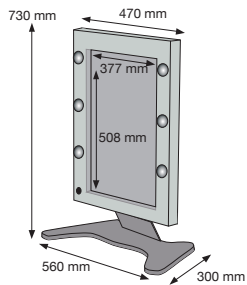

CE CE Certification - 220V & 110V - for EU and US standard

THE ORIGINAL ONE

[www.cantonionline.com](http://www.cantonionline.com)

MADE IN ITALY



## ART. LTV - LTVX2



LTV Specchio da tavolo in legno laccato, illuminazione I-LIGHT con 6 punti luce, pulsante di accensione.

LTV FULL MIRROR Specchio da tavolo in legno laccato, illuminazione I-LIGHT con 6 punti luce e pulsante di accensione.

LTVX2 , specchio su entrambi i lati : fornita solo con specchio incorniciato.

Colori disponibili: Nero, Bianco, Fucsia, Silver.

CE CE Certification - 220V & 110V - for EU and US standard



# ART. LTV - LTVX2



LTV Desk mirror, in lacquered wood, with I-LIGHT Technology system, 6 spot lights.

LTV FULL MIRROR Desk mirror, in lacquered wood, with I-LIGHT Technology system, 6 spot lights.

LTVX2, both sides mirror: supplied only with framed mirror version.

Available colors: black, white, silver, fuchsia.

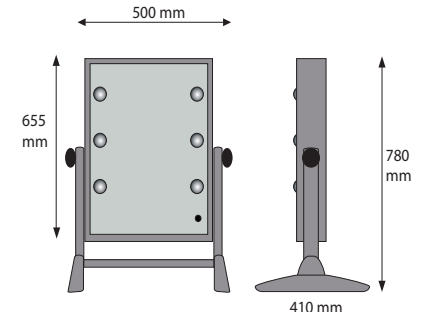

## BAULETTI - LINEA SOFT

Linea di bauletti, di produzione Italiana, in tessuto tecnico imbottito e antistrappo. Diverse tipologie e misure con cassetti inseriti in una struttura rigida incorporata, spazi termici per mantenere il caldo o il freddo, trolley incorporato. Capienti e versatili sono consigliati a truccatori, parrucchieri, podologi, nail artists.

- ▶ FACILITÀ DI TRASPORTO
- ▶ FACILE PULIZIA
- ▶ GARANZIA 2 ANNI & CERTIFICAZIONE CE

## BAULETTI - LINEA RIGIDA

Linea di bauletti e valigie in struttura rigida, con trolley e ruote, in diverse misure e modelli, allestiti internamente con spazi modulari e cassetti.

POSSIBILITÀ DI REALIZZAZIONI SU MISURA

- ▶ FACILITÀ DI TRASPORTO
- ▶ FACILE PULIZIA
- ▶ GARANZIA 2 ANNI & CERTIFICAZIONE CE

## BAG & TROLLEY - SOFT LINE

Line of Bags of Italian handmade production, in Padded Tearingproof Fabric. Various models with different dimensions, with drawers and trolley incorporated. Special area with thermal insulation where to keep warm or cold. Capacious and versatile they are recommended for Make up Artists, Hairstylists, podiatrists and nail artists.

- ▶ PORTABILITY
- ▶ EASY TO CLEAN
- ▶ 2 YEAR WARRANTY & CE CERTIFICATION

## SUITCASE LINE

Line of cases with rigid structure, with trolley, different dimensions and models with inner modular spaces and drawers.

FOR THIS TYPE OF PRODUCTION IT IS POSSIBLE TO MAKE CUSTOMIZED ITEMS

- ▶ PORTABILITY
- ▶ EASY TO CLEAN
- ▶ 2 YEAR WARRANTY & CE CERTIFICATION







### HIGH BOX TROLL.FR

Ampia tasca superiore, cassettera composta da 2 cassetti bassi 1 cassetto alto Trolley incorporato

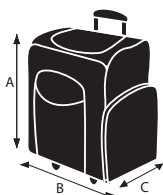

|   | A mm | B mm | C mm | Kg  |
|---|------|------|------|-----|
| Highbox troll                                   | 540  | 400  | 300  | 5.5 |
| cass.alto dim. interne<br>high drawer inn. dim. | 100  | 310  | 200  |     |
| cass.basso dim interne<br>low drawer inn. dim.  | 50   | 310  | 200  |     |



### HIGH BOX TROLL.FR

Composed by a capacious upper pocket with thermal insulation, provided with gel pack, a rigid structure which contains a drawers set with 2 high +1 low drawers. Incorporated trolley



### FITBOX TROLL.FR

Ampia tasca superiore, cassettera composta da 1 cassetto alto. Trolley incorporato

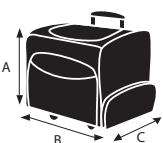

|   | A mm | B mm | C mm | Kg  |
|---|------|------|------|-----|
| Fitbox troll                                    | 400  | 400  | 300  | 4.0 |
| cass.alto dim. interne<br>high drawer inn. dim. | 100  | 310  | 200  |     |



### FITBOX TROLL.FR

Composed by a capacious upper pocket with thermal insulation, provided with gel pack, a rigid structure which contains 1 high drawer. Incorporated trolley





### BEAUTY BOX TROLL.FR

3 tasche esterne, cassettiera composta da 2 cassetti bassi 1 cassetto alto. Trolley incorporato

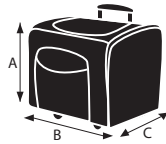

|   | A<br>mm | B<br>mm | C<br>mm | Kg  |
|---|---------|---------|---------|-----|
| Beautybox troll                                 | 400     | 400     | 300     | 5.0 |
| cass.alto dim. interne<br>high drawer inn. dim. | 100     | 310     | 200     |     |
| cass.basso dim interne<br>low drawer inn. dim.  | 50      | 310     | 200     |     |



### BEAUTY BOX TROLL.FR

Composed by 3 external pockets, a rigid structure which contains a drawer set with 2 high +1 low drawers. Incorporated trolley



### BMT.3

Tasca superiore, 2 tasche esterne, cassettiera composta da 3 cassetti bassi. Trolley incorporato

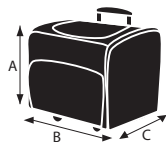

|  | A<br>mm | B<br>mm | C<br>mm | Kg  |
|--|---------|---------|---------|-----|
| BMT.3  | 450     | 410     | 290     | 3.8 |
| cass.basso dim interne<br>low drawer inn. dim. | 50      | 310     | 200     |     |



### BMT.3

Composed by 2 external pockets, a capacious upper pocket with thermal insulation provided with gel pack, a rigid structure which contains 3 low drawers. Incorporated trolley





### BMT.6

Tasca superiore, 2 tasche esterne,  
cassettiera composta da  
4 cassetti bassi  
1 cassetto alto.  
Trolley incorporato

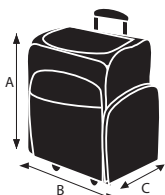

### BMT.6

Composed by 2 external pockets,  
a capacious upper pocket with thermal  
insulation provided with gel pack, a rigid  
structure which contains  
4 low +1 high drawers.  
Incorporated trolley

|   | A<br>mm | B<br>mm | C<br>mm | Kg  |
|---|---------|---------|---------|-----|
| BMT.6   | 610     | 410     | 290     | 6.6 |
| cass.alto dim. interne<br>high drawer inn. dim. | 100     | 310     | 200     |     |
| cass.basso dim interne<br>low drawer inn. dim.  | 50      | 310     | 200     |     |







### BMU.3

Tasca superiore che può contenere lampada UV, 2 tasche esterne, cassettera fornita con 3 cofanetti. Trolley incorporato

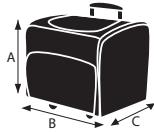

|                               | A<br>mm | B<br>mm | C<br>mm | Kg  |
|-------------------------------|---------|---------|---------|-----|
| BMU.3                         | 430     | 400     | 300     | 5.6 |
| dim. cofanetti<br>casket dim. | 50      | 364     | 248     |     |



### BMU.3

Composed by a capacious upper pocket which can contain an UV lamp, 2 external pockets, a rigid structure which contains 3 caskets. Incorporated trolley



### BMU.6

Tasca superiore che può contenere lampada UV, 1 tasca esterna, cassettera fornita con 6 cofanetti. Trolley incorporato

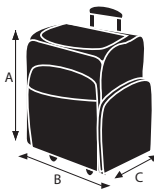

|                               | A<br>mm | B<br>mm | C<br>mm | Kg  |
|-------------------------------|---------|---------|---------|-----|
| BMU.6                         | 640     | 400     | 300     | 8.4 |
| dim. cofanetti<br>casket dim. | 50      | 364     | 248     |     |



### BMU.6

Composed by a capacious upper pocket which can contain an UV lamp, 1 external pocket, a rigid structure which contains 6 caskets. Incorporated trolley





### BB2.T

Ampio spazio interno, tasca esterna.  
Sul retro è presente una patella per inserimento su trolley.



### BB2.T

Composed by a capacious inner space,  
1 external pocket. On the back a band is applied for hand trolley inser-  
tion, which serves to transport 2 bags at same time.



### BB2.N

Ampio spazio interno, tasca esterna.  
La versione BB2.N è fornita con cofanetti. Sul retro è presente una  
patella per inserimento su trolley.



### BB2.N

Composed by a capacious inner space,  
1 external pocket. The version BB2.N is provided of caskets.  
On the back a band is applied for hand trolley insertion, which serves to  
transport 2 bags at same time.

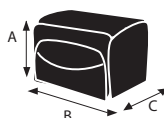

|                               | A<br>mm | B<br>mm | C<br>mm | Kg  |
|-------------------------------|---------|---------|---------|-----|
| BB2                           | 230     | 370     | 280     | 1.0 |
| dim. cofanetti<br>casket dim. | 50      | 364     | 248     |     |

### COFANETTI

Scatole semitrasparenti, con coperchio, divisori regolabili all'interno.  
Per minuteria e piccoli accessori.

### CASKETS

Translucent boxes, with cover, adjustable dividers for small  
accessories and products.





**GV NAILS**  
Trolley con 10 cofanetti.

**COFANETTI**  
Scatole semitrasparenti, con coperchio, divisori regolabili all'interno. Per minuteria e piccoli accessori.



**GV NAILS**  
Trolley with 10 caskets.

**CASKETS**  
Translucent boxes, with cover, adjustable dividers for small accessories and products.

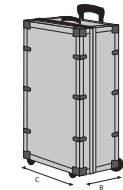

|                               | A<br>mm | B<br>mm | C<br>mm | Kg   |
|-------------------------------|---------|---------|---------|------|
| GV NAILS                      | 725     | 295     | 390     | 12.0 |
| dim. cofanetti<br>casket dim. | 50      | 248     | 364     |      |



**GV10**  
Capiente valigia, con 2 cassetti alti e 6 cassetti bassi, configurazioni diverse su richiesta



Capacious case with a drawer set composed by 2 high + 6 low drawers.

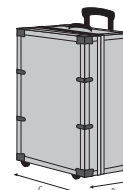

|   | A<br>mm | B<br>mm | C<br>mm | Kg  |
|---|---------|---------|---------|-----|
| GV.10 NEW                                       | 600     | 340     | 410     | 8.3 |
| cass.alto dim. interne<br>high drawer inn. dim. | 100     | 190     | 350     |     |
| cas.basso dim interne<br>low drawer inn. dim.   | 50      | 190     | 350     |     |





ST113  
Porta-pennelli con astuccio interno



ST113  
Brush-holder, internal pocket with zip



ST114 + KH  
Cintura regolabile con tasche e  
porta-pennelli  
+ portasalviette (non incluso)



ST114 + KH  
Adjustable belt with pocket and  
brush-holder  
+ Kleenex holder (not included)



KH  
Portasalviette



KH  
Kleenex holder



B03  
Borsa/marsupio con tasche.  
Può essere applicata  
al bracciolo della sedia.



B03  
Purse/Marsupium pouch  
with pocket.  
Can be applied  
to the arm of the chair.

HR SYSTEM + KH + B03





### X4 ROLLING SYSTEM

Molto utile per spostare facilmente la postazione durante l'utilizzo, l'applicazione del Rolling system alza la postazione di 10 cm.



### X4 ROLLING SYSTEM

Very handy to move easily the station during make-up performance. Useful to raise 10 cm the station.



### SGABELLI

Di facile trasporto e grande praticità, gli sgabelli pieghevoli sono disponibili in 3 diverse altezze: 45, 55 e 65 cm. Perfetti per parrucchieri, estetisti, nail artistse make-up artists sempre in movimento!



### STOOL

Folding tripod stools, available in 3 different sizes: 45, 55, 65 cm. Ideal for hairstylists, beauticians, nail artists and make up artists always on the move.

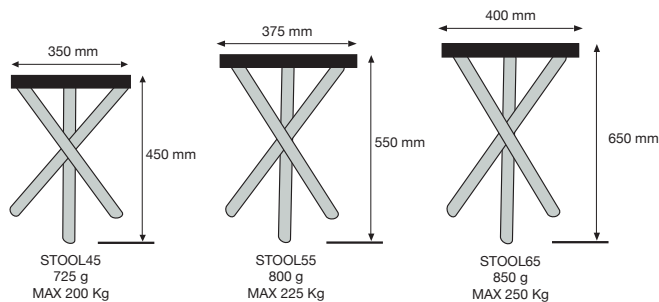



## ILLUMINATORI

Composti da 1 lampada professionale e 1 ombrello montati su treppiede arricchiscono le postazioni make up creando una luce diffusa e gradevole. Fungono da insegna pubblicitaria e attirano l'attenzione poiché ricordano un set cinematografico.

Versioni disponibili:

**TRI 650** – kit composto da :

Lampada professionale 650 watt, treppiede, ombrello. Abbinato alla comoda custodia **W806**.

La lampada **L650**, utilizzata negli studi fotografici, ha una resa altamente professionale e crea una luce diffusa; è ventilata.

## OMBRELLI PROFESSIONALI

L'ombrello professionale colore nero **WOS3003** viene fornito con custodia.

L'ombrello inoltre può essere personalizzato con il vostro logo.



## LIGHTING KIT

Composed by 1 professional lamp and 1 umbrella mounted on tripod, they improve the make up stage creating big impression, they serve as luminous sign attracting large audience and diffuses a pleasant light.

Available versions:

**TRI 650** – kit composed by :

Professional lamp 650 watt, tripod, umbrella. Supplied with a bag for an easy transport **W806**.

The **L650** lamp, utilized in photo shooting, is highly professional and creates a pleasant ambience. It is ventilated.

## PROFESSIONAL UMBRELLA

**WOS3003** black professional umbrella. Supplied with transport bag.

The umbrella can be personalized with your logo.



W806 + WOS3003



L650



TRI 650



TRI425 - kit composto da:

Lampada a basso consumo 80 watt, resa 400 watt, treppiede, ombrello. Abbinato alla comoda custodia W806.

La lampada WOF4005, è una lampada a basso consumo ma ad alta resa di luce.

#### OMBRELLI PROFESSIONALI

L'ombrello professionale colore bianco WU43 viene fornito con custodia.

L'ombrello inoltre può essere personalizzato con il vostro logo.



TRI425 - kit composed by:

Low power consumption lamp 80 watt, generating 400 watt, tripod, umbrella. Supplied with a bag for an easy transport W806.

WOF4005 is a very useful lamp characterized by low power consumption but very high light performance.

**PROFESSIONAL UMBRELLA**  
WU43 white professional umbrella.  
Supplied with transport bag.

The umbrella can be personalized with your logo.



TRI 425

## GRANDI TRASPORTI

Linea di valigie di grande capienza, in resina plastica ad alto spessore, a tenuta stagna, resistenti agli urti, agli agenti chimici, alla polvere. Per il trasporto di equipaggiamenti e attrezzature, garantendone la massima protezione. Serrature con lucchetto a combinazione.

## GREAT TRANSPORTS

Line of capacious cases, Waterproof, resistant to chemicals, humidity, dust, shocks. To transport safely sensitive instruments and equipments. With combination locks.



Predisposte per l'inserimento di lucchetti in vari punti della valigia.

Possibility to insert locks in several positions.



Dimensioni interne - Inner Dim. 517 x 277 x 217 mm



5833  
Dimensioni interne - Inner Dim. 580 x 440 x 330 mm  
7630  
Dimensioni interne - Inner Dim. 765 x 485 x 305 mm  
7641  
Dimensioni interne - Inner Dim. 765 x 485 x 415 mm

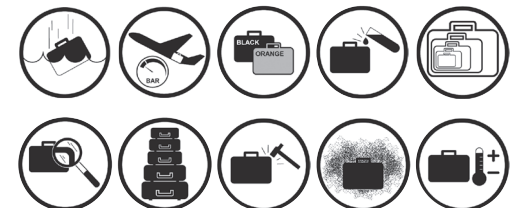

CE



 Le valigie della serie GRANDI TRASPORTI sono impilabili e caratterizzate da interni personalizzabili con borse componibili o spugna sagomata.

A lato un esempio di stoccaggio di diversi prodotti Cantoni, tra cui una sedia S102.A una postazione trucco trasportabile e alcuni accessori.

 The GREAT TRANSPORT series suitcases are stackable and characterized by customizable interiors. The options are padded bags or precubed foam.

A side an example of storage of different products Cantoni, including a chair S102.A, a portable make-up station and some accessories.

Dimensioni interne - Inner Dim. 765 x 485 x 415 mm



Dimensioni interne - Inner Dim. 1080 x 620 x 400 mm



I prodotti Cantoni sono esclusivamente prodotti e ideati in Italia.  
Per qualsiasi richiesta siamo a disposizione

We desire to remark that the design and the production of all  
Cantoni items are absolutely MADE IN ITALY  
For any further requirement don't hesitate to contact us

CANTONI TRADING SRL  
Strada degli Angariari, 25 - 47891 Rovereta - Rep. San Marino  
Tel. +378 0549 977527 - Fax +378 0549 876501  
[info@cantonionline.com](mailto:info@cantonionline.com)

La ditta Cantoni si riserva il diritto di modificare in qualsiasi momento gli articoli a catalogo per motivi tecnico commerciali.  
Cantoni company reserves the right to modify the article at any time for technical or commercial reasons.

© Tutti i diritti sono riservati /All Rights Reserved